



Industry First Low Capacitance ESD Protection Arrays w/Backdrive Protection

CM1223

Features

- Two, four, and eight channels of ESD protection with integrated backdrive protection on all lines
- Provides ESD protection to IEC61000-4-2 Level 4:
 - $\pm 8\text{kV}$ contact discharge
 - $\pm 15\text{kV}$ air discharge
- Low channel input capacitance of 1.0pF (typical)
- Minimal capacitance change with temperature and voltage
- Channel I/O to GND capacitance difference of 0.02pF typical is ideal for differential signals
- Mutual capacitance between signal pin and adjacent signal pin at 0.11pF (typical)
- Zener diode protects supply rail and eliminates the need for external bypass capacitors
- Pin compatible with CM1213-02, -04, and -08
- Each I/O pin can withstand over 1000 ESD strikes*
- Available in SOT, and MSOP packages
- RoHS-compliant, lead-free packaging

Applications

- USB2.0 ports at 480Mbps in desktop PCs, notebooks and peripherals
- IEEE1394 Firewire® ports at 400Mbps / 800Mbps
- DVI ports, HDMI ports in notebooks, set top boxes, digital TVs, LCD displays
- UDI and display ports
- Serial ATA ports in desktop PCs and hard disk drives
- PCI Express ports
- General purpose high-speed data line ESD protection

Product Description

The CM1223 family of diode arrays are designed to provide ESD protection for electronic components or subsystems requiring minimal capacitive loading. These devices are ideal for protecting systems with high data and clock rates or for circuits requiring low capacitive loading. Each ESD channel consists of a pair of diodes in series, which steer the positive or negative ESD current pulse to either the positive (V_p) or negative (V_N) supply rail. A Zener diode is embedded between V_p and V_N , to absorb positive ESD strikes and provide ESD protection for the V_p rail. An additional diode is integrated to serve as backdrive current protection. The CM1223 protects against ESD pulses up to $\pm 8\text{kV}$ per the IEC 61000-4-2 standard. In addition, all pins are protected from contact discharges of greater than $\pm 15\text{kV}$ as outlined by the MIL-STD-883D (Method 3015) specification for Human Body Model (HBM) ESD.

These devices are particularly well-suited for protecting systems using high-speed ports such as USB2.0, IEEE1394 (Firewire®, iLink™), serial ATA, DVI, HDMI and corresponding ports in removable storage, digital camcorders, DVD-RW drives, as well as other applications where extremely low loading capacitance with ESD protection are required in a small package footprint.

The CM1223 family of devices are manufactured with RoHS-compliant, lead-free packaging.

Block Diagram

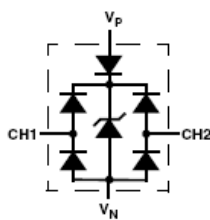

CM1223-02SO
CM1223-02SR

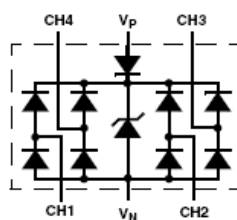

CM1223-04SO
CM1223-04MR

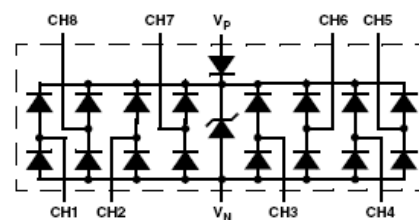

CM1223-08MR

Package/Pinout Diagrams

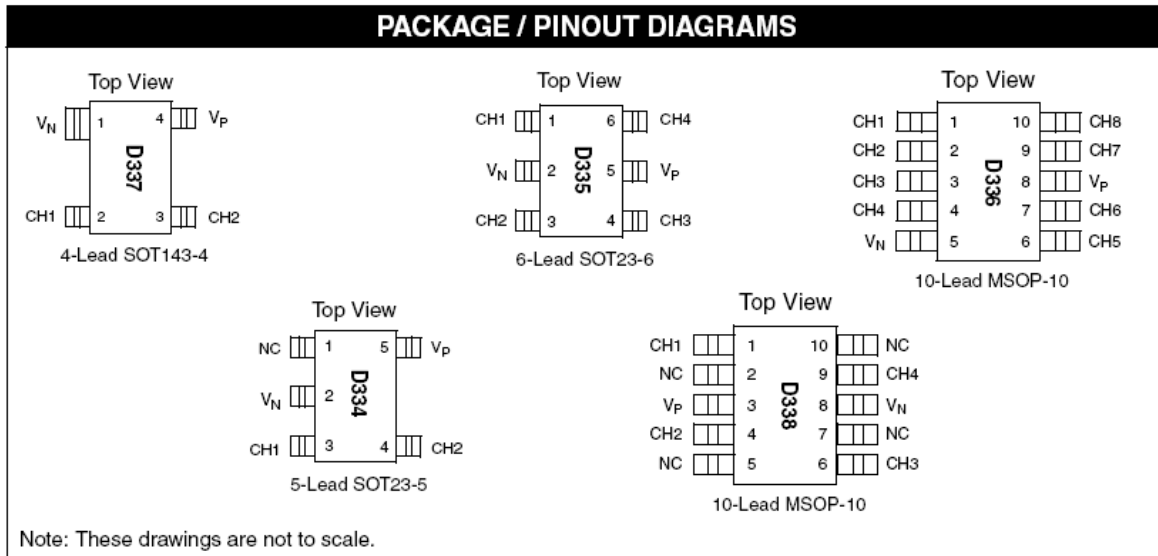

CM1223

Pin Configuration

2-CHANNEL, 4-LEAD SOT143-4 PACKAGE

PIN	NAME	TYPE	DESCRIPTION
1	V _N	GND	Negative voltage supply rail
2	CH1	I/O	ESD Channel
3	CH2	I/O	ESD Channel
4	V _P	PWR	Positive voltage supply rail

2-CHANNEL, 5-LEAD SOT23-5 PACKAGE

PIN	NAME	TYPE	DESCRIPTION
1	NC		No connect
2	V _N	GND	Negative voltage supply rail
3	CH1	I/O	ESD Channel
4	CH2	I/O	ESD Channel
5	V _P	PWR	Positive voltage supply rail

4-CHANNEL, 6-LEAD SOT23-6 PACKAGE

PIN	NAME	TYPE	DESCRIPTION
1	CH1	I/O	ESD Channel
2	V _N	GND	Negative voltage supply rail
3	CH2	I/O	ESD Channel
4	CH3	I/O	ESD Channel
5	V _P	PWR	Positive voltage supply rail
6	CH4	I/O	ESD Channel

4-CHANNEL, 10-LEAD MSOP-10 PACKAGE

PIN	NAME	TYPE	DESCRIPTION
1	CH1	I/O	ESD Channel
2	NC		No connect
3	V _P	PWR	Positive voltage supply rail
4	CH2	I/O	ESD Channel
5	NC		No connect
6	CH3	I/O	ESD Channel
7	NC		No connect
8	V _N	GND	Negative voltage supply rail
9	CH4	I/O	ESD Channel
10	NC		No connect

8-CHANNEL, 10-LEAD MSOP-10 PACKAGE

PIN	NAME	TYPE	DESCRIPTION
1	CH1	I/O	ESD Channel
2	CH2	I/O	ESD Channel
3	CH3	I/O	ESD Channel
4	CH4	I/O	ESD Channel
5	V _N	GND	Negative voltage supply rail
6	CH5	I/O	ESD Channel
7	CH6	I/O	ESD Channel
8	V _P	PWR	Positive voltage supply rail
9	CH7	I/O	ESD Channel
10	CH8	I/O	ESD Channel

Ordering Information

PART NUMBERING INFORMATION				
# of Channels	Leads	Package	Ordering Part Number ¹	Part Marking
2	5	SOT23-5	CM1223-02SO	D334
2	4	SOT143-4	CM1223-02SR	D337
4	6	SOT23-6	CM1223-04SO	D335
4	10	MSOP-10	CM1223-04MR	D338
8	10	MSOP-10	CM1223-08MR	D336

Note 1: Parts are shipped in Tape and Reel form unless otherwise specified.

Specifications

ABSOLUTE MAXIMUM RATINGS		
PARAMETER	RATING	UNITS
Operating Supply Voltage ($V_P - V_N$)	6.0	V
Operating Temperature Range	-40 to +85	°C
Storage Temperature Range	-65 to +150	°C
DC Voltage at any channel input	$(V_N - 0.5)$ to $(V_P + 0.5)$	V

STANDARD OPERATING CONDITIONS		
PARAMETER	RATING	UNITS
Operating Temperature Range	-40 to +85	°C
Package Power Rating		
SOT143-4 Package (CM1223-02SR)	225	mW
SOT23-5 Package (CM1223-02SO)	225	mW
SOT23-6 Package (CM1223-04SO)	225	mW
MSOP-10 Package (CM1223-04MR)	400	mW
MSOP-10 Package (CM1223-08MR)	400	mW

ELECTRICAL OPERATING CHARACTERISTICS (SEE NOTE 1)

SYMBOL	PARAMETER	CONDITIONS	MIN	TYP	MAX	UNITS
V_P	Operating Supply Voltage (V_P-V_N)			3.3	5.5	V
I_P	Operating Supply Current	$(V_P-V_N)=3.3V$			8.0	μA
V_{SCL}	Signal Clamp Voltage Positive Transients Negative Transients	$I_F = 8mA; T_A=25^\circ C$	6.7 0.60	8.2 0.80		V V
I_{LEAK}	Channel Leakage Current	$T_A=25^\circ C; V_P=5V, V_N=0V$		± 0.1	± 1.0	μA
C_{IN}	Channel Input Capacitance	At 1 MHz, $V_P=3.3V, V_N=0V, V_{IN}=1.65V$		1.0	1.5	pF
ΔC_{IN}	Channel Input Capacitance Matching	At 1 MHz, $V_P=3.3V, V_N=0V, V_{IN}=1.65V$		0.02		pF
C_{MUTUAL}	Mutual Capacitance between signal pin and adjacent signal pin	At 1 MHz, $V_P=3.3V, V_N=0V, V_{IN}=1.65V$		0.11		pF
V_{ESD}	ESD Protection Peak Discharge Voltage at any channel input, in system a) Contact discharge per IEC 61000-4-2 standard b) Human Body Model, MIL-STD-883, Method 3015	$T_A=25^\circ C$; Notes 3 and 4 $T_A=25^\circ C$; Notes 2 and 4	± 8 ± 15			kV kV
V_{CL}	Channel Clamp Voltage Positive Transients Negative Transients	$T_A=25^\circ C, I_{PP} = 1A, t_p = 8/20\mu S$; Note 4		+8.8 -1.4		V V
R_{DYN}	Dynamic Resistance Positive Transients Negative Transients	$T_A=25^\circ C, I_{PP} = 1A, t_p = 8/20\mu S$ Any I/O pin to Ground; Note 4		0.7 0.4		Ω Ω

Note 1: All parameters specified at $T_A = -40^\circ C$ to $+85^\circ C$ unless otherwise noted.

Note 2: Human Body Model per MIL-STD-883, Method 3015, $C_{Discharge} = 100pF, R_{Discharge} = 1.5K\Omega, V_P = 3.3V, V_N$ grounded.

Note 3: Standard IEC 61000-4-2 with $C_{Discharge} = 150pF, R_{Discharge} = 330\Omega, V_P = 3.3V, V_N$ grounded.

Note 4: These measurements performed with no external capacitor on V_P (V_P floating).

Performance Information

Input Channel Capacitance Performance Curves

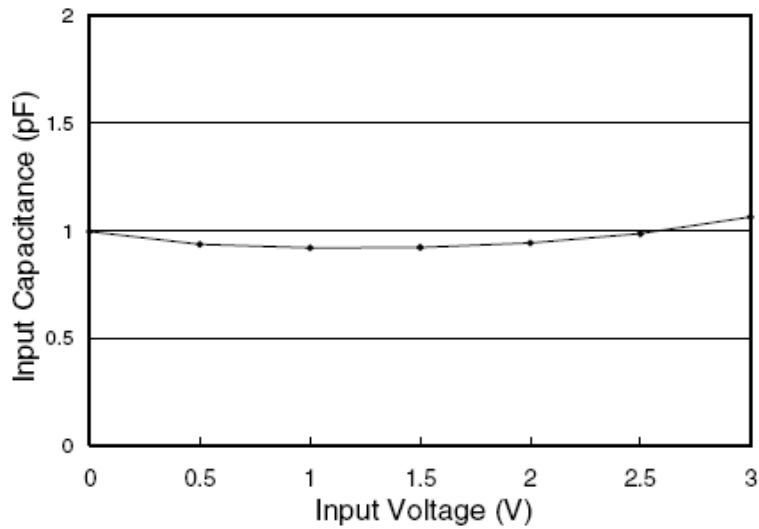

Typical Variation of C_{IN} vs. V_{IN}

(f=1MHz, V_P = 3.3V, V_N = 0V, 0.1 μF chip capacitor between V_P and V_N, 25°C)

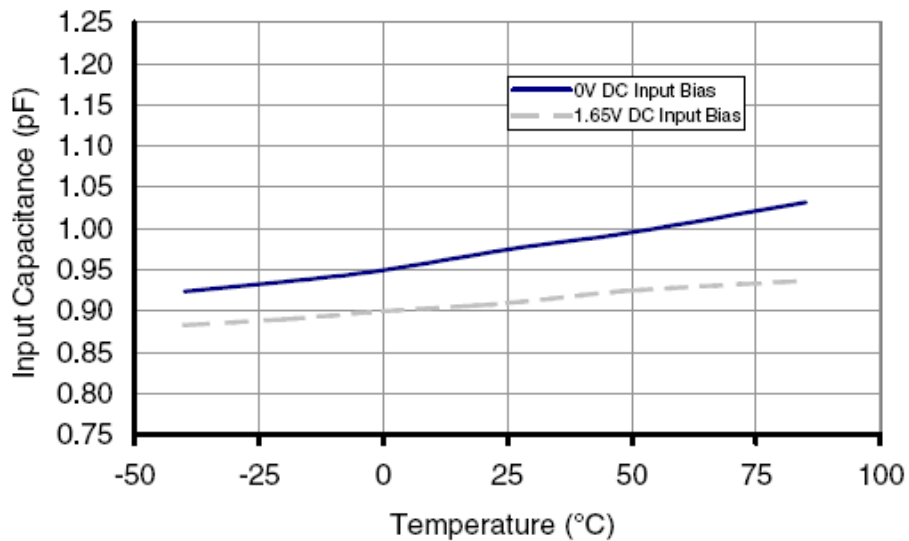

Typical Variation of C_{IN} vs. Temp

(f=1MHz, V_{IN}=30mV, V_P = 3.3V, V_N = 0V, 0.1 μF chip capacitor between V_P and V_N)

Performance Information (Cont'd)

Typical Filter Performance (nominal conditions unless specified otherwise, 50 Ohm Environment)

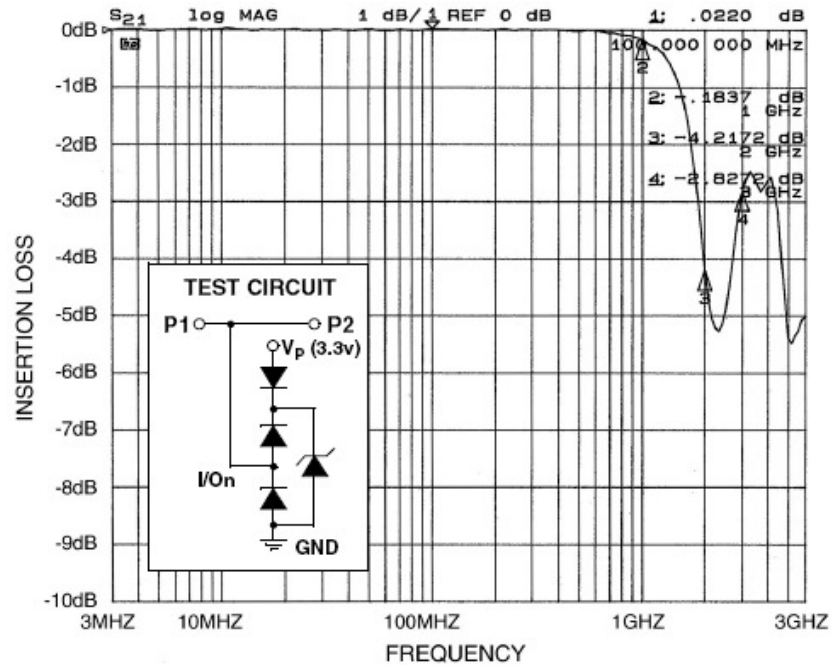

Figure 1. Insertion Loss (S₂₁) VS. Frequency (0V DC Bias, V_p=3.3V, MSOP-8 Package)

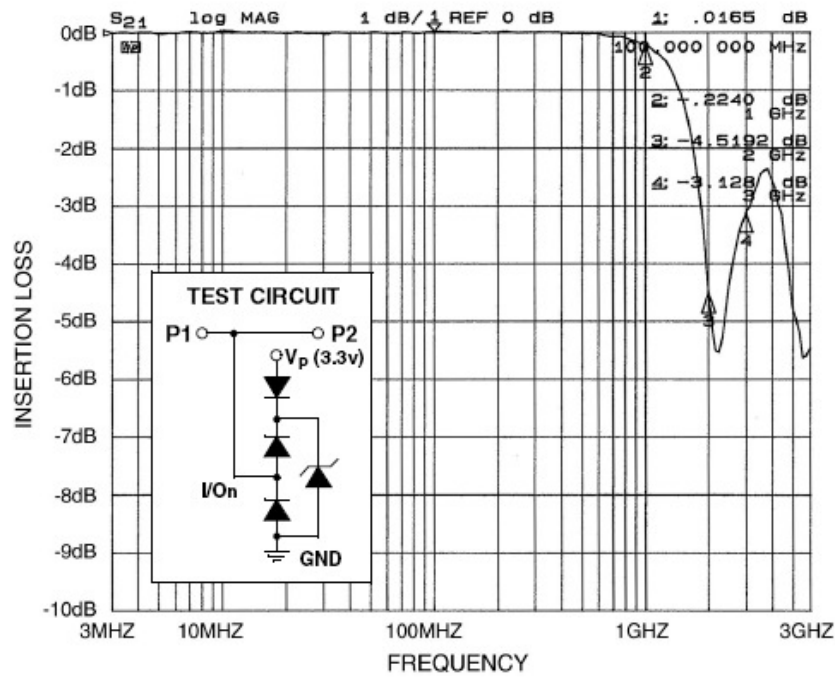

Figure 2. Insertion Loss (S₂₁) VS. Frequency (2.5V DC Bias, V_p=3.3V, MSOP-8 Package)

Performance Information (Cont'd)

Typical Filter Performance (nominal conditions unless specified otherwise, 50 Ohm Environment)

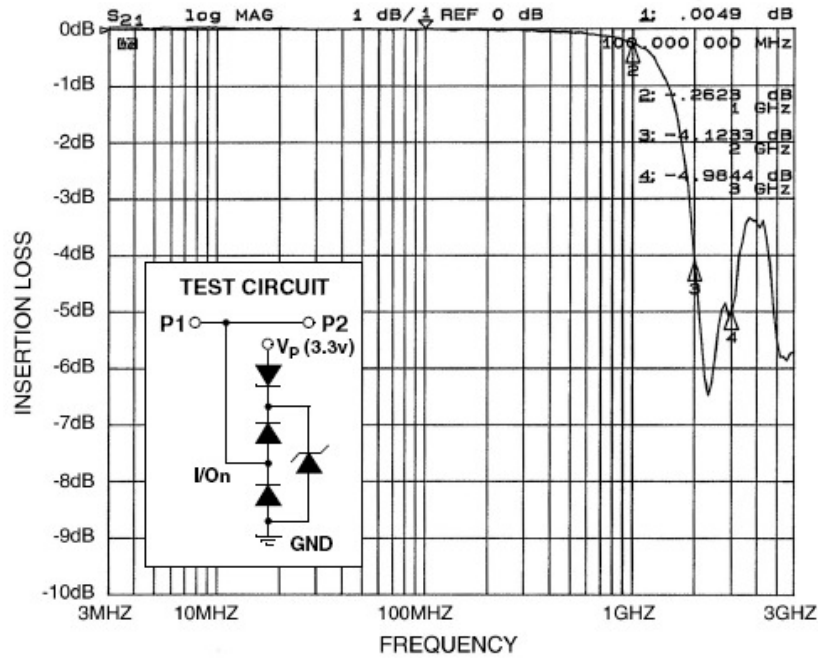

Figure 3. Insertion Loss (S21) VS. Frequency (0V DC Bias, $V_p=3.3V$, MSOP-10 Package)

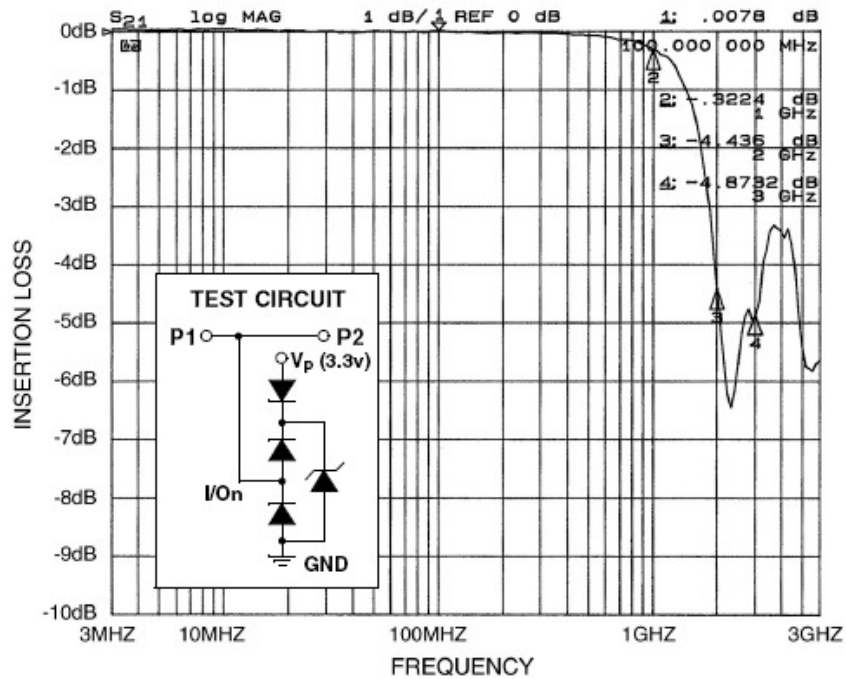

Figure 4. Insertion Loss (S21) VS. Frequency (2.5V DC Bias, $V_p=3.3V$)

Backdrive Protection

Backdrive protection is needed to block against backdrive current flowing from a high potential voltage node toward a lower potential voltage node through the interface cable.

For example, consider a DVD player connected to a TV via an HDMI interface. If the DVD player is switched off and the TV is left on, there is a possibility of reverse current flow back into the main power supply rail of the DVD player. Typically, the DVD's power supply has some form of associated bulk supply capacitance, and it is possible over time to charge that bulk supply capacitance to some intermediate level.

If that level rises above the power-on-reset (POR) voltage level of some of the integrated circuits, the DVD player may not reset properly when the DVD player is turned back on. This is largely because all CMOS logic exhibits a very high impedance on the power rail node even when "off".

To avoid this situation, the CM1223 with integrated backdrive protection diode was designed to block backdrive current, guaranteeing no more than 5 μ A on any I/O pin when the I/O pin voltage is greater than the CM1223 supply voltage.

Application Information

Design Considerations

To realize the maximum protection against ESD pulses, care must be taken in the PCB layout to minimize parasitic series inductances on the Supply/Ground rails as well as the signal trace segments between the signal input (typically a connector) and the ESD protection device. Application of Positive ESD Pulse between Input Channel and Ground illustrates an example of a positive 8kV ESD pulse striking an input channel. The 8kV ESD current pulse will divert along the path as indicated in Application of Positive ESD Pulse between Input Channel and Ground, through the D1 diode and the Zener diode back to the ground rail.

An ESD current pulse can rise from zero to its peak value in a very short time. For example, a level 4 contact discharge per the IEC61000-4-2 standard results in a current pulse that rises from zero to 30 Amps in 1ns. The CM1223 has a fast response time of less than 1ns and low clamp voltage to handle this pulse scenario.

Similarly for negative ESD pulses, parasitic series inductance from the V_N pin to the ground rail will lead to drastically increased negative voltage on the line being protected.

The CM1223 also has an integrated backdrive diode between V_P and V_N to prevent backdrive current flow from the powered sources.

As a general rule, the ESD Protection Array should be located as close as possible to the point of entry of expected electrostatic discharges.

Additional Information

See also California Micro Devices Application Note AP209, "Design Considerations for ESD Protection", in the Applications section at www.cmd.com.

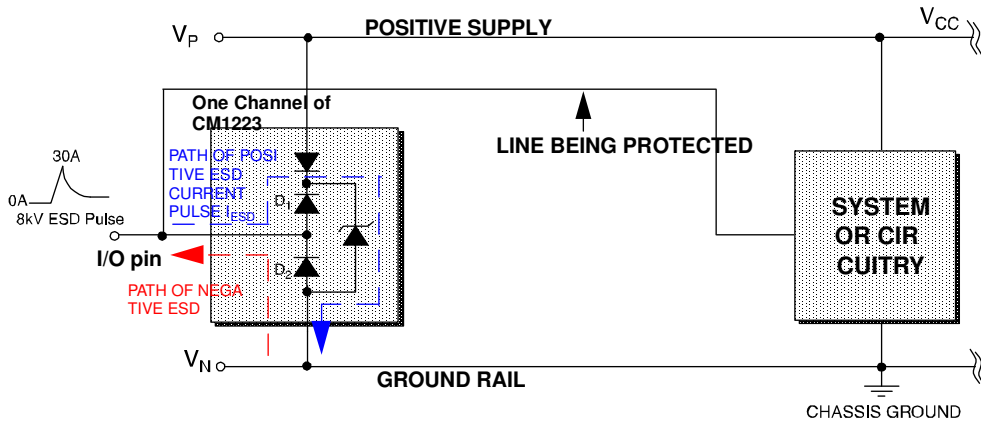

Figure 5. Application of Positive ESD Pulse between Input Channel and Ground

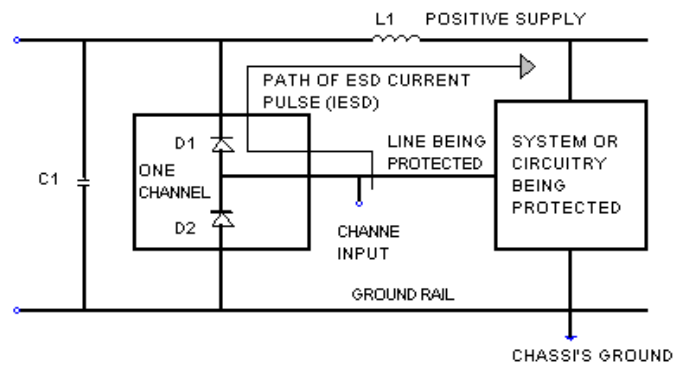

Figure 6. Application of Positive ESD Pulse between Input Channel and Ground

CM1223

Mechanical Details

The CM1223 is available in SOT143-4, SOT23-5, SOT23-6, and MSOP-10 packages with a lead-free finishing option. The various package drawings are presented below.

SOT143 Mechanical Specifications

Dimensions for CM1223-02SR devices supplied in 4-pin SOT143 packages are presented below.

PACKAGE DIMENSIONS				
Package	SOT143			
Pins	4			
Dimensions	Millimeters		Inches	
	Min	Max	Min	Max
A	0.80	1.22	0.031	0.048
A1	0.05	0.15	0.002	0.006
b	0.30	0.50	0.012	0.019
b2	0.76	0.89	0.030	0.035
c	0.08	0.20	0.003	0.008
D	2.80	3.04	0.110	0.119
E	2.10	2.64	0.082	0.103
E1	1.20	1.40	0.047	0.055
e	1.92 BSC		0.075 BSC	
e1	0.20 BSC		0.008 BSC	
L	0.4	0.6	0.016	0.024
L1	0.54 REF		0.021 REF	
# per tape and reel	3000 pieces			
Controlling dimension: millimeters				

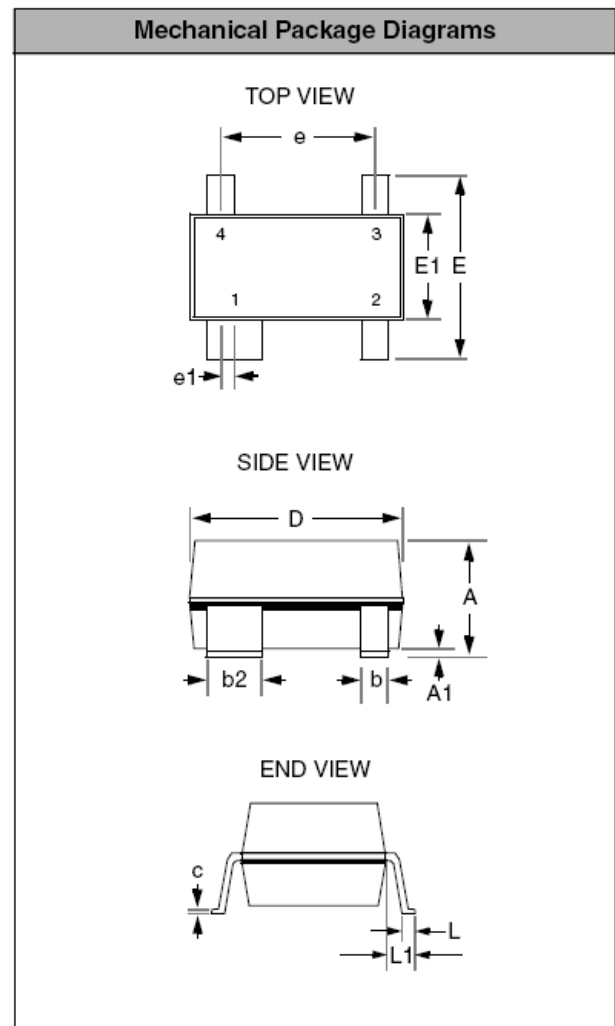

Package Dimensions for SOT143

Tape and Reel Specifications

PART NUMBER	PACKAGE SIZE (mm)	POCKET SIZE (mm) $B_0 \times A_0 \times K_0$	TAPE WIDTH W	REEL DIAMETER	QTY PER REEL	P_0	P_1
CM1223-02SR	2.92 X 2.37 X 1.01	2.60 X 3.15 X 1.20	8mm	178mm (7")	3000	4mm	4mm

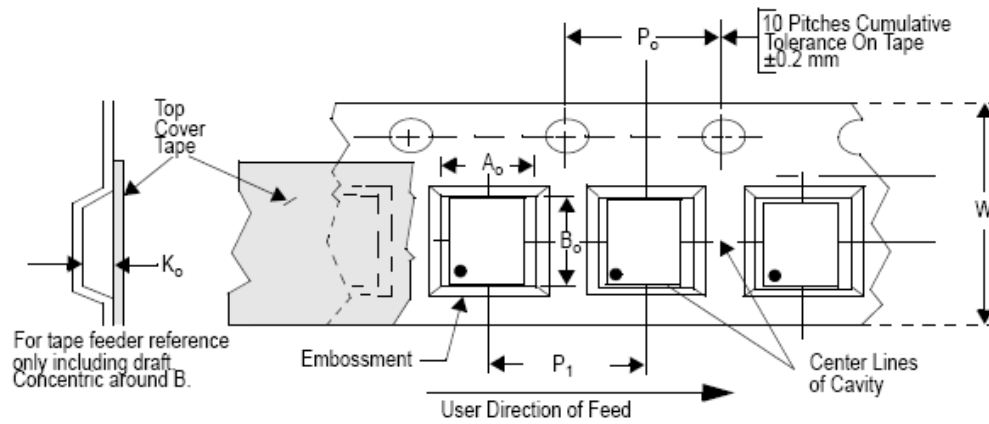

CM1223

Mechanical Details (cont'd)

SOT23-5 Mechanical Specifications

The CM1223-02SO is supplied in a 5-pin SOT23 package. Dimensions are presented below.

PACKAGE DIMENSIONS				
Package	SOT23-5 (JEDEC name is MO-178)			
Pins	5			
Dimensions	Millimeters		Inches	
	Min	Max	Min	Max
A	--	1.45	--	0.0571
A1	0.00	0.15	0.0000	0.0059
b	0.30	0.50	0.0118	0.0197
c	0.08	0.22	0.0031	0.0087
D	2.75	3.05	0.1083	0.1201
E	2.60	3.00	0.1024	0.1181
E1	1.45	1.75	0.0571	0.0689
e	0.95 BSC		0.0374 BSC	
e1	1.90 BSC		0.0748 BSC	
L	0.30	0.60	0.0118	0.0236
L1	0.60 REF		0.0236 REF	
# per tape and reel	3000 pieces			
Controlling dimension: millimeters				

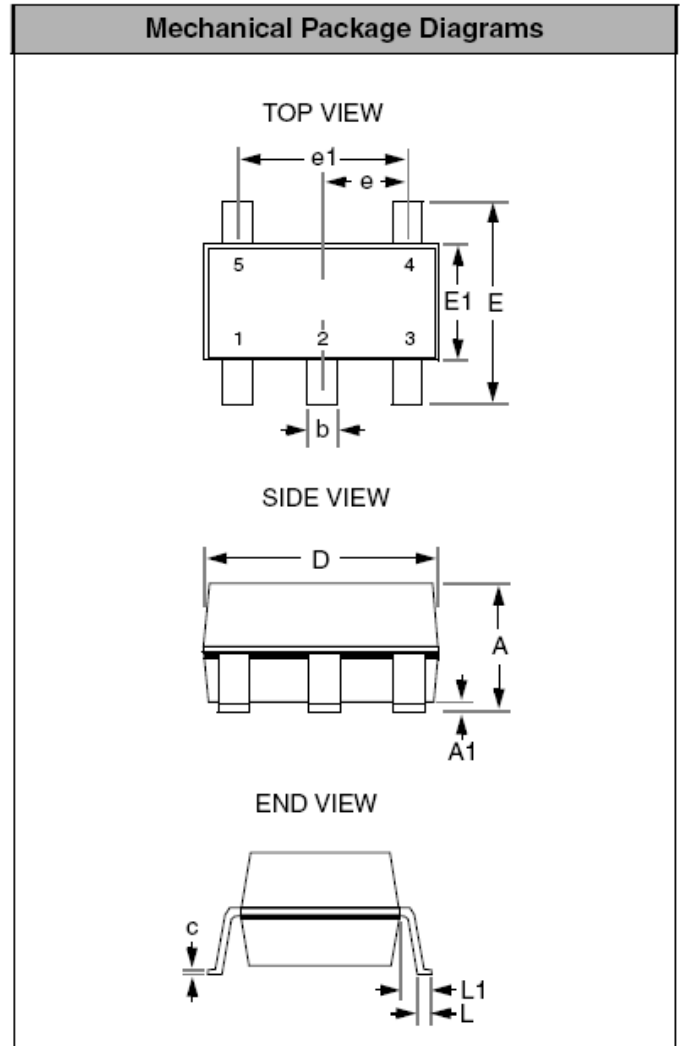

Package Dimensions for SOT23-5

Tape and Reel Specifications

PART NUMBER	PACKAGE SIZE (mm)	POCKET SIZE (mm) $B_0 \times A_0 \times K_0$	TAPE WIDTH W	REEL DIAMETER	QTY PER REEL	P_0	P_1
CM1223-02SO	2.90 X 2.80 X 1.45	3.20 X 3.20 X 1.40	8mm	178mm (7")	3000	4mm	4mm

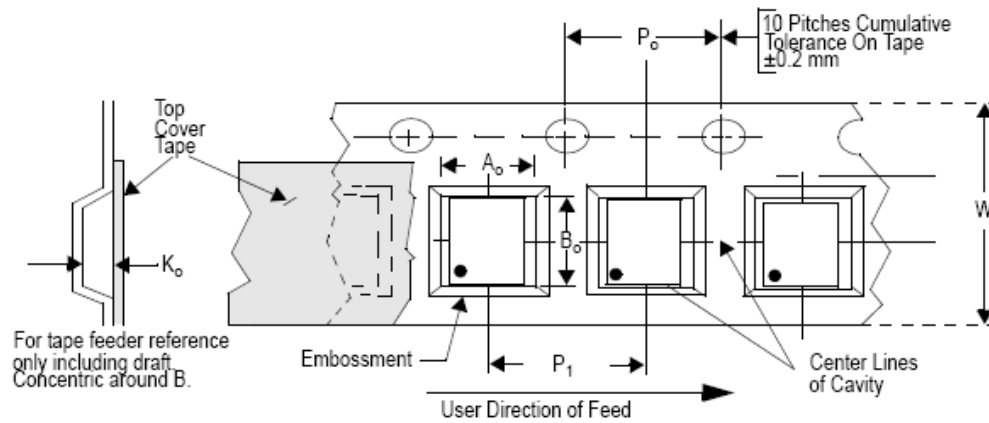

CM1223

Mechanical Details (cont'd)

SOT23-6 Mechanical Specifications

CM1223-04SO devices are packaged in 6-pin SOT23 packages. Dimensions are presented below.

PACKAGE DIMENSIONS				
Package	SOT23-6 (JEDEC name is MO-178)			
Pins	6			
Dimensions	Millimeters		Inches	
	Min	Max	Min	Max
A	--	1.45	--	0.0571
A1	0.00	0.15	0.0000	0.0059
b	0.30	0.50	0.0118	0.0197
c	0.08	0.22	0.0031	0.0087
D	2.75	3.05	0.1083	0.1201
E	2.60	3.00	0.1024	0.1181
E1	1.45	1.75	0.0571	0.0689
e	0.95 BSC		0.0374 BSC	
e1	1.90 BSC		0.0748 BSC	
L	0.30	0.60	0.0118	0.0236
L1	0.60 REF		0.0236 REF	
# per tape and reel	3000 pieces			
Controlling dimension: millimeters				

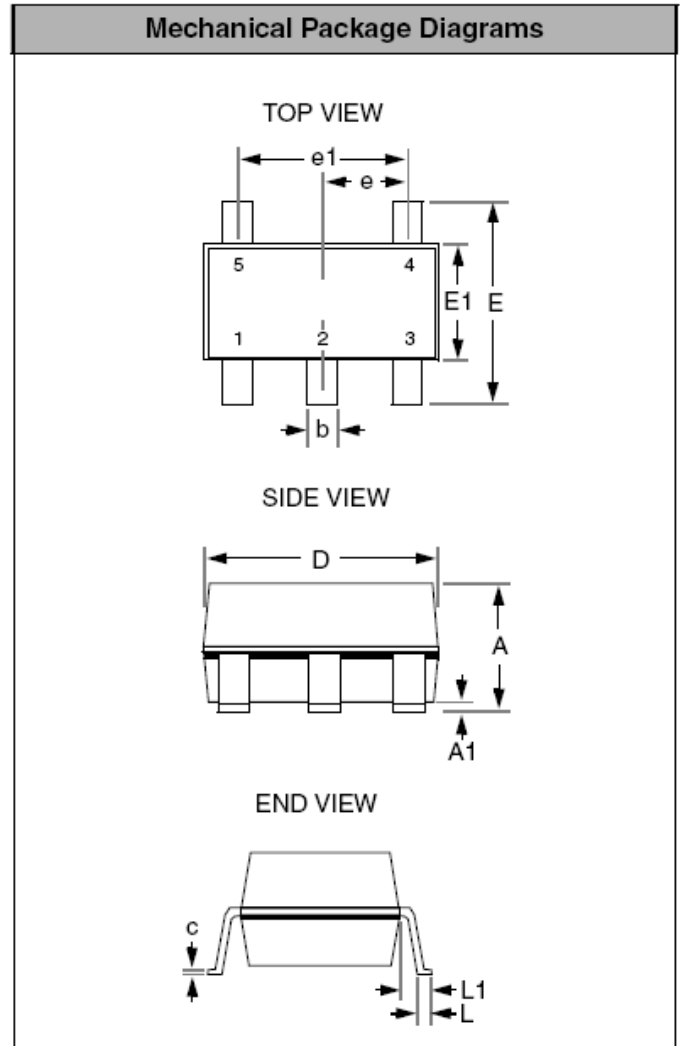

Package Dimensions for SOT23-6

Tape and Reel Specifications

PART NUMBER	PACKAGE SIZE (mm)	POCKET SIZE (mm) $B_0 \times A_0 \times K_0$	TAPE WIDTH W	REEL DIAMETER	QTY PER REEL	P_0	P_1
CM1223-04SO	2.90 X 2.80 X 1.45	3.20 X 3.20 X 1.40	8mm	178mm (7")	3000	4mm	4mm

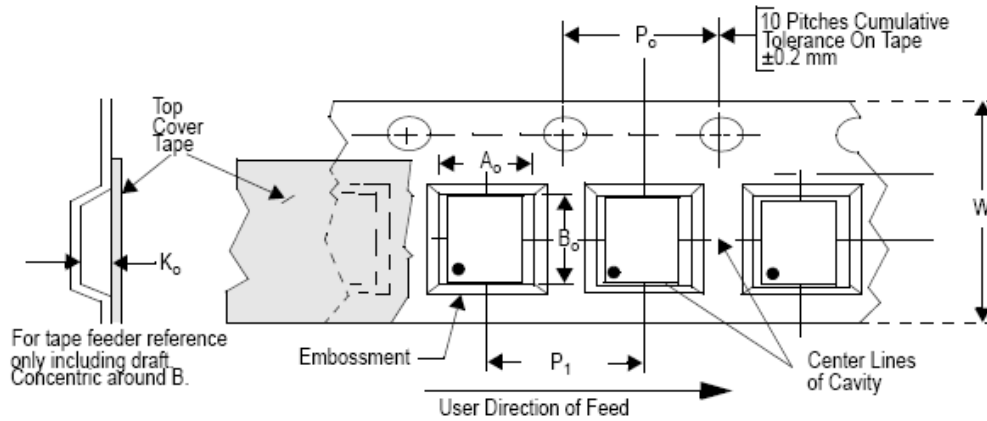

CM1223

Mechanical Details (cont'd)

MSOP-10 Mechanical Specifications, 10 pin

The CM1223-08MR 10-lead MSOP package dimensions are presented below.

PACKAGE DIMENSIONS				
Package	MSOP			
Pins	10			
Dimensions	Millimeters		Inches	
	Min	Max	Min	Max
A	0.75	0.95	0.028	0.038
A1	0.05	0.15	0.002	0.006
B	0.17	0.27	0.007	0.013
C	0.13	0.23	0.005	0.009
D	2.90	3.10	0.114	0.122
E	2.90	3.10	0.114	0.122
e	0.50 BSC		0.0196 BSC	
H	4.90 BSC		0.193 BSC	
L	0.40	0.70	0.0137	0.029
# per tape and reel	4000			
Controlling dimension: millimeters				

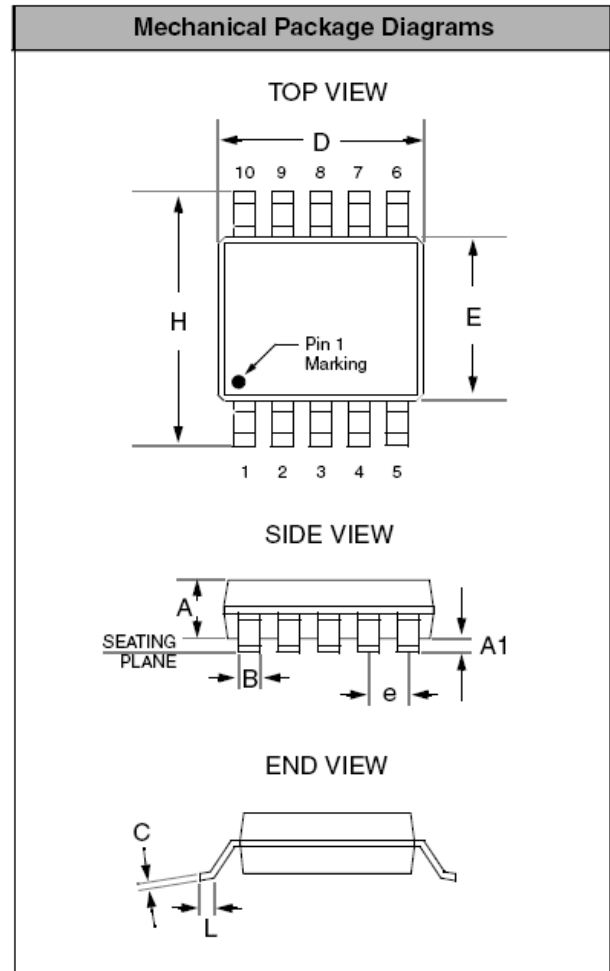

Package Dimensions for MSOP-10

Tape and Reel Specifications

PART NUMBER	PACKAGE SIZE (mm)	POCKET SIZE (mm) $B_o \times A_o \times K_o$	TAPE WIDTH W	REEL DIAMETER	QTY PER REEL	P_o	P_1
CM1223-08MR	3.00 X 3.00 X 0.85	3.30 X 5.30 X 1.30	12mm	330mm (13")	4000	4mm	8mm

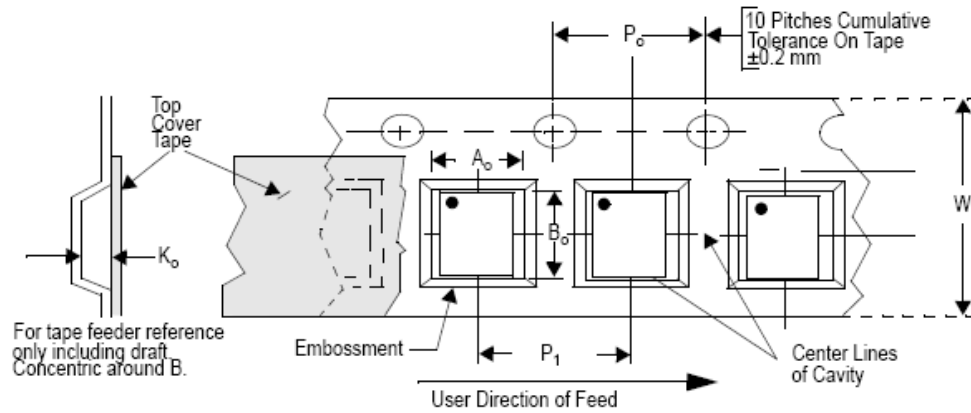

ON Semiconductor and  are registered trademarks of Semiconductor Components Industries, LLC (SCILLC). SCILLC reserves the right to make changes without further notice to any products herein. SCILLC makes no warranty, representation or guarantee regarding the suitability of its products for any particular purpose, nor does SCILLC assume any liability arising out of the application or use of any product or circuit, and specifically disclaims any and all liability, including without limitation special, consequential or incidental damages. "Typical" parameters which may be provided in SCILLC data sheets and/or specifications can and do vary in different applications and actual performance may vary over time. All operating parameters, including "Typicals" must be validated for each customer application by customer's technical experts. SCILLC does not convey any license under its patent rights nor the rights of others. SCILLC products are not designed, intended, or authorized for use as components in systems intended for surgical implant into the body, or other applications intended to support or sustain life, or for any other application in which the failure of the SCILLC product could create a situation where personal injury or death may occur. Should Buyer purchase or use SCILLC products for any such unintended or unauthorized application, Buyer shall indemnify and hold SCILLC and its officers, employees, subsidiaries, affiliates, and distributors harmless against all claims, costs, damages, and expenses, and reasonable attorney fees arising out of, directly or indirectly, any claim of personal injury or death associated with such unintended or unauthorized use, even if such claim alleges that SCILLC was negligent regarding the design or manufacture of the part. SCILLC is an Equal Opportunity/Affirmative Action Employer. This literature is subject to all applicable copyright laws and is not for resale in any manner.

PUBLICATION ORDERING INFORMATION

LITERATURE FULFILLMENT:

Literature Distribution Center for ON Semiconductor

P.O. Box 5163, Denver, Colorado 80217 USA

Phone: **303-675-2175 or 800-344-3860 Toll Free USA/Canada**

Fax: **303-675-2176 or 800-344-3867 Toll Free USA/Canada**

Email: **orderlit@onsemi.com**

N. American Technical Support: **800-282-9855**

Toll Free USA/Canada

Europe, Middle East and Africa Technical Support:

Phone: 421 33 790 2910

Japan Customer Focus Center

Phone: 81-3-5773-3850

ON Semiconductor Website: www.onsemi.com

Order Literature: <http://www.onsemi.com/orderlit>

For additional information, please contact your local Sales Representative